





| 产品图片 | Features 产品特性 | Application 应用 |
|--|---|---|
|  DIP8  SMD8 | <ul style="list-style-type: none"> ●Contact Form 触点形式 1a/1b ●Load Voltage 输出电压 400V ●Load Current 输出电流 0.1A ●Low Off-State Leakage Current 漏电流 1 (N.O.) 10 (N.C.) μA | <ul style="list-style-type: none"> ●Automatic Test Equipment 自动检测设备 ●Telephone Equipment 通信设备 ●Sensing Equipment 传感设备 ●Security Equipment 安全设备 ●I/O Modules I/O 模块 ●Modem 调制解调器 |

Type 种类

| Output rating 输出额定 | | Marking model 标刻型号 | Part No. 订货型号 | |
|----------------------|-----------------------|-----------------------|---------------|-------------|
| Load voltage 负载电压 | Load current 负 载电流 | | DIP 双列直插 | SMD 表面贴装 |
| 400V | 0.1A | BCW614 | BCW614 | BCW614A |

注：表示引脚类型的“A”未标刻在产品上，订货依据订货示例型号。

Dimensions 外形尺寸

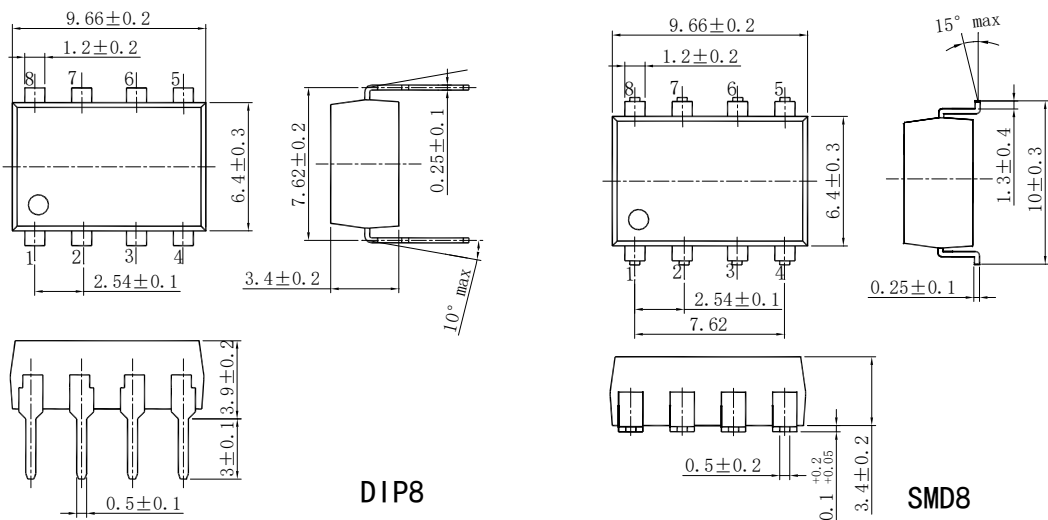

Terminal Identification 引脚标识

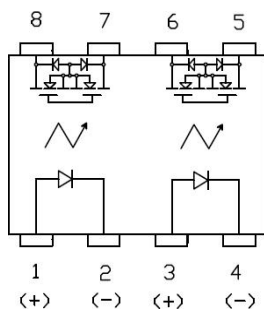

Wiring Diagram 接线图

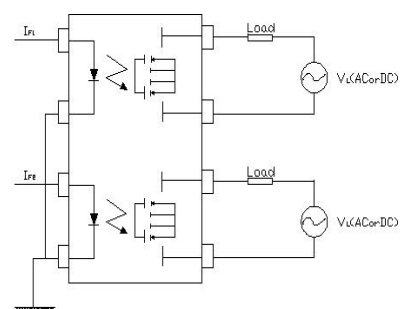

通讯地址：陕西省西安市国家民用航天产业基地航天中路385号众创广场11层1101.1102.1104室

生产地址：陕西省宝鸡市陈仓区群力路1号邮政编码：721300

电话：(0917)-6293969 18609177833

传 真：(0917)-6293969



PhotoMOS 光 MOS 继电器 (SMD8/DIP8)

Technical parameters 技术参数 (Ambient Temperature 25°C)

I/O Absolute Maximum Ratings 输入输出电气参数最大值

| Item 项目 | Symbol 符号 | BCW614 | | |
|---------------------------------------|---|--------------|------------|----------------------|
| Operating Temperature 工作温度 | T_{OPR} | -40°C~+85°C | | |
| Storage Temperature 储存温度 | T_{STG} | -40°C~+100°C | | |
| Input 输入 | Continuous LED Current 工作电流 | MAX. 最大值 | I_F | 50mA |
| | Peak LED Current LED 峰值电流 (f=100Hz, Duty=1%) | MAX. 最大值 | I_{FP} | 1000mA |
| | LED Reverse Voltage 反向电压 | MAX. 最大值 | V_R | 5V |
| | Input Power Dissipation 输入功耗 | MAX. 最大值 | P_{IN} | 75mW |
| Output 输出 | Load Voltage 输出电压 | MAX. 最大值 | V_L | 400V (AC peak or DC) |
| | Load Current 输出电流 | MAX. 最大值 | I_L | 0.1A |
| | Peak Load Current 峰值输出电流 (1ms, 1shot) | MAX. 最大值 | I_{PEAK} | 0.6A |
| | Output Power Dissipation 输出功耗 | MAX. 最大值 | P_{OUT} | 450mW |
| Total Power Dissipation 总功耗 | MAX. 最大值 | P_T | 500mW | |
| I/O Breakdown Voltage 输入输出间隔电压 | MAX. 最大值 | $V_{I/O}$ | 3750Vrms | |
| I/O Breakdown Voltage 输入输出间隔电压 (加注 H) | MAX. 最大值 | $V_{I/O}$ | 5000Vrms | |

Electrical Specifications 输入输出电气参数

| Item 项目 | Symbol 符号 | BCW614 | Conditions 条件 | |
|---------------------------|--------------------------------|----------|------------------------------|---|
| Input 输入 | LED Forward Voltage 正向电压 | TYP. 典型值 | 1.2V | $I_F=10mA$ |
| | | MAX. 最大值 | 1.5V | |
| | Operation LED Current 接通电流 | TYP. 典型值 | 0.5mA | |
| | | MAX. 最大值 | 5mA | |
| Recovery LED Voltage 关断电压 | MIN. 最小值 | 0.5V | | |
| Output 输出 | On-Resistance 导通电阻 | TYP. 典型值 | 20 (N.O.) 20 (N.C.) Ω | $I_F=5mA$ (N.O.) $I_F=0mA$ (N.C.) $I_L=100mA$ within 1sec. |
| | | MAX. 最大值 | 30 (N.O.) 50 (N.C.) Ω | |
| | Off-State Leakage Current 漏电流 | MAX. 最大值 | 1 (N.O.) 10 (N.C.) μA | $I_F=0mA$ (N.O.) $I_F=5mA$ (N.C.) $V_L=Rating$ |
| | Output Capacitance 输出端容量 | TYP. 典型值 | 150pF | $I_F=5mA, V_L=0V,$ $f=1MHz$ |
| Time parameters 时间参数 | Turn-On Time 接通时间 | TYP. 典型值 | 0.23 (N.O.) 0.2 (N.C.) ms | $I_F=5mA,$ $I_L=50mA$ |
| | | MAX. 最大值 | 0.5 (N.O.) 1 (N.C.) ms | |
| | Turn-Off Time 关断时间 | TYP. 典型值 | 0.03 (N.O.) 0.5 (N.C.) ms | |
| | | MAX. 最大值 | 0.2 (N.O.) 3 (N.C.) ms | |
| I/O 输入输出 | I/O Insulation Resistance 绝缘电阻 | MIN. 最小值 | 1000M Ω | DC500V |
| | I/O Capacitance 隔离电容 | TYP. 典型值 | 0.8pF | f=1MHz |

通讯地址: 陕西省西安市国家民用航天产业基地航天中路385号众创广场11层1101.1102.1104室

生产地址: 陕西省宝鸡市陈仓区群力路1号 邮政编码: 721300

电话: (0917)-6293969 18609177833

传 真: (0917)-6293969



PhotoMOS 光 MOS 继电器 (SMD8/DIP8)

Reference Data 参考数值 (BCW614)

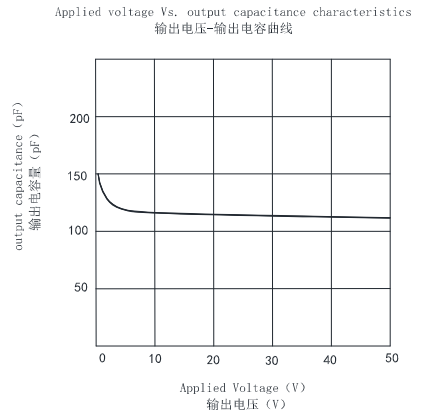
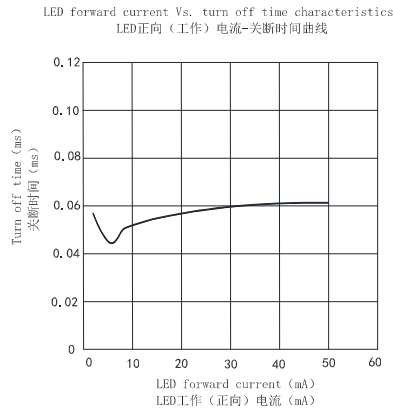
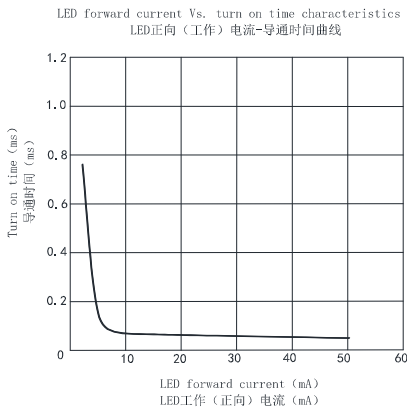
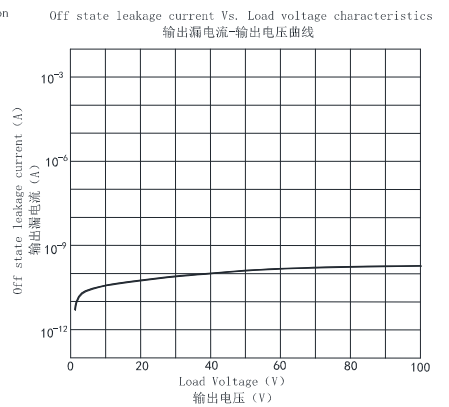
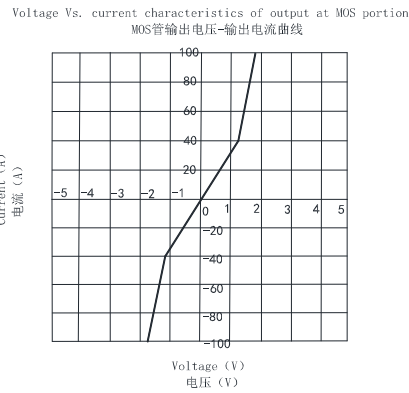
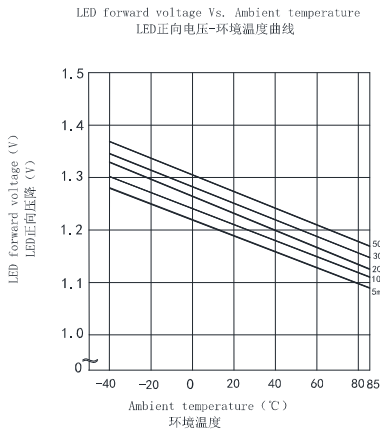
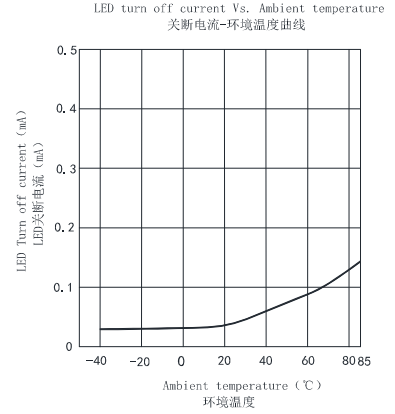
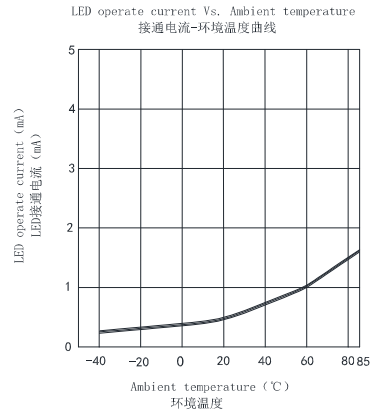
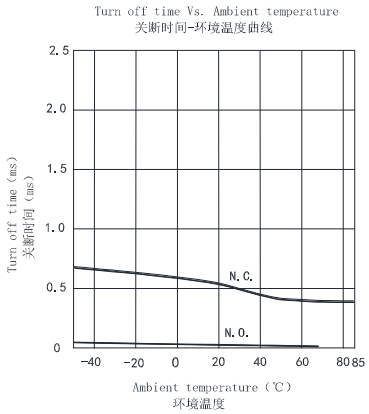
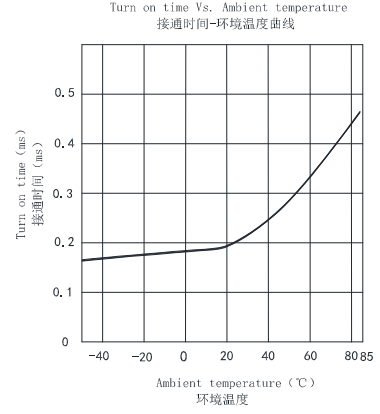
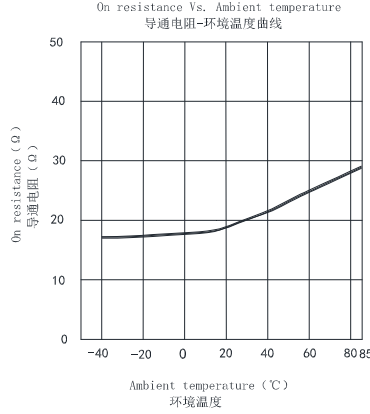
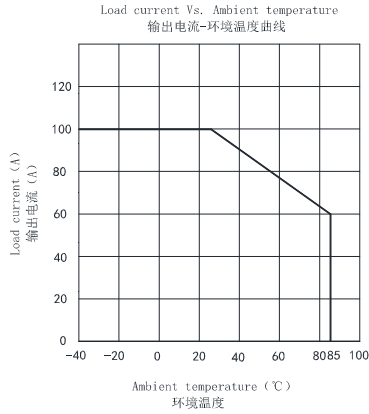

通讯地址: 陕西省西安市国家民用航天产业基地航天中路385号众创广场11层1101.1102.1104室

生产地址: 陕西省宝鸡市陈仓区群力路1号 邮政编码: 721300

电话: (0917)-6293969 18609177833

传 真: (0917)-6293969